

THIS DRAWING IS UNPUBLISHED. RELEASED FOR PUBLICATION
 © COPYRIGHT - By - ALL RIGHTS RESERVED.

LOC	DIST	REVISIONS			
P	LTR	DESCRIPTION	DATE	DWN	APVD
BD	39	P			
		P	REVISED PER ECO-11-004835	11MAR11	RK HMR

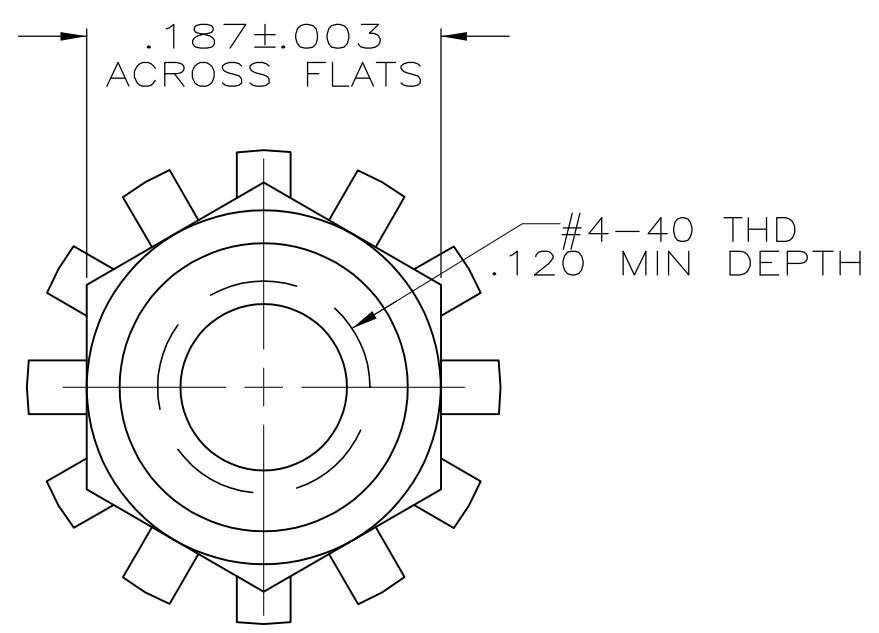
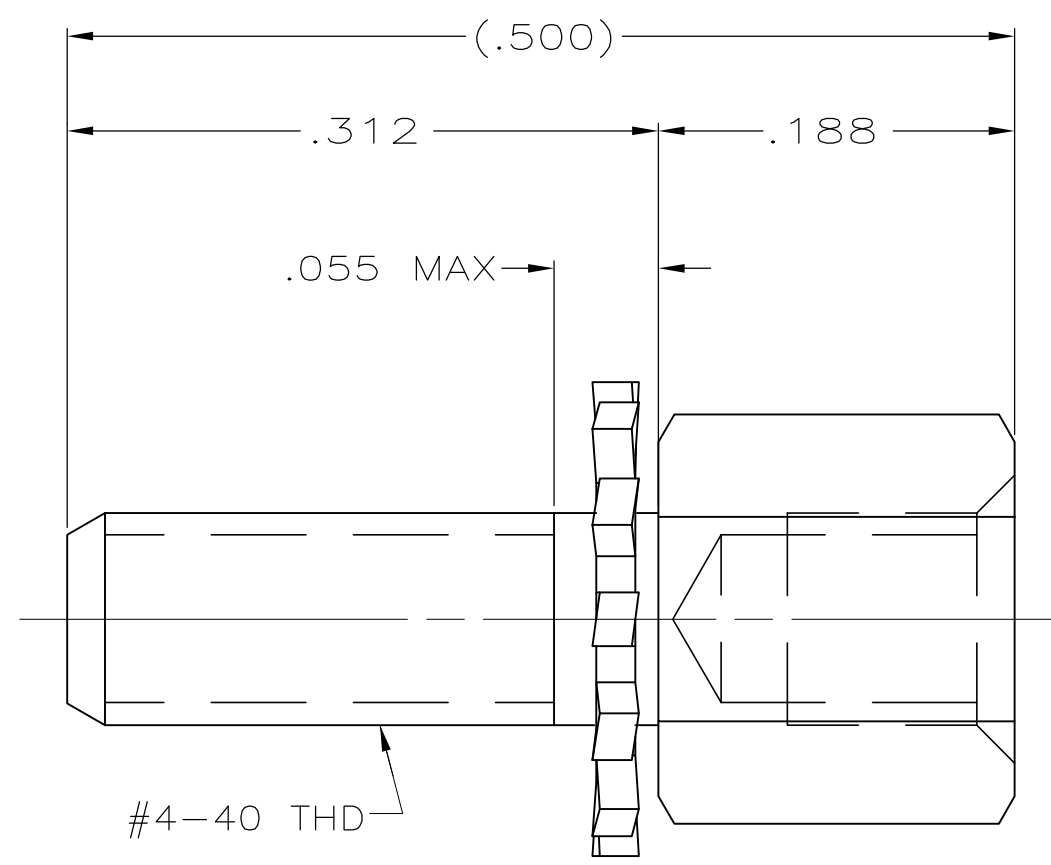

- 1 ZINC PLATED .000200-.000400 THICK CLEAR CHROMATE COATING.
- 2 PARTS PACKAGED AS A UNIT KIT.
- 3 PARTS INDIVIDUALLY BULK PACKED & SHIPPED AS A UNIT PACKAGE.

PACKAGING	QUANTITY	FINISH	PART NO
3	2	1	5748558-4
2	2	1	5748558-3

THIS DRAWING IS A CONTROLLED DOCUMENT.		DWN R.RICHARDSON 29JUN05	STE TE Connectivity													
DIMENSIONS: INCHES		CHK J.GERACE 29JUN05														
TOLERANCES UNLESS OTHERWISE SPECIFIED:		APVD M.WALMSLEY 29JUN05	NAME FEMALE SCREWLOCK KIT, W/ EXTERNAL TOOTH LOCK WASHER, AMPLIMITE													
<table border="0"> <tr><td>0 PLC</td><td>± -</td></tr> <tr><td>1 PLC</td><td>± -</td></tr> <tr><td>2 PLC</td><td>± -</td></tr> <tr><td>3 PLC</td><td>± .005</td></tr> <tr><td>4 PLC</td><td>± -</td></tr> <tr><td>ANGLES</td><td>± -</td></tr> </table>		0 PLC	± -	1 PLC	± -	2 PLC	± -	3 PLC	± .005	4 PLC	± -	ANGLES	± -	PRODUCT SPEC -	-	
0 PLC	± -															
1 PLC	± -															
2 PLC	± -															
3 PLC	± .005															
4 PLC	± -															
ANGLES	± -															
MATERIAL COLD ROLLED STEEL	FINISH SEE TABLE	APPLICATION SPEC -	SIZE A3	CAGE CODE 00779	DRAWING NO C-5748558	RESTRICTED TO -										
CUSTOMER DRAWING			SCALE 10:1	SHEET 1 OF 1	REV P											